

	Pag
- SPECIFICATIONS	200
PUMP SPECIFICATION	200
MOTOR SPECIFICATION	201
SELECTION CHART	202-203
TYPE KEY AND CURVES SPECIFICATIONS	204-205
PERFORMANCE CURVE 4WN1	206
PERFORMANCE CURVE 4WN2	207
PERFORMANCE CURVE 4WN3	208
PERFORMANCE CURVE 4WN4	209
PERFORMANCE CURVE 4WN5	210
PERFORMANCE CURVE 4WN6	211
PERFORMANCE CURVE 4WN8	212
PERFORMANCE CURVE 4WN10	213
PERFORMANCE CURVE 4WN12	214
PERFORMANCE CURVE 4WN15	215
- CONSTRUCTIONS	300
SECTIONAL VIEW	300
- DIMENSIONS	400
DIMENSIONS 4WN1 TO 4WN5	401
DIMENSIONS 4WN6 TO 4WN15	402
WEIGHT 4WN1 TO 4WN5	403
WEIGHT 4WN6 TO 4WN15	404
- PACKING	405
PACKING 4WN1 TO 4WN5	405
PACKING 4WN6 TO 4WN15	406

PUMP		
Liquid Handled	Type of liquid	Clean water
	Temperature [°C]	Maximum 35 (depends on maximum motor temperature)
	Sand content	Maximum : 50 g/mc
	Chlorine ion density	Maximum : 500 parts per million
Construction	Impeller	Closed centrifugal - Floating type
	Bearing	Sleeve type - Sintered (AISI304) / Urethane
Pipe connection	Suction	N/A
	Discharge	RP1 1/4 (models 4WN1 to 4WN4) UNI ISO 7/1
		RP1 1/2 (models 4WN5) UNI ISO 7/1
Material	RP2 (models 4WN6 to 4WN15) UNI ISO 7/1	
	Impeller	PPO mod. + Glass Fibre reinforced
	Intermediate casing	EN 1.4301 (AISI 304)
	Diffuser	Polycarbonate Glass Fibre reinforced
	Shaft	EN 1.4301 (AISI 304)
	Coupling	Sintered type (AISI304)
	Discharge Head	EN 1.4301 (AISI 304)
	Valve	EN 1.4301 (AISI 304)
Bracket	EN 1.4308 (ASTM CF8)	
Applicable standard of test		ISO 9906 - Annex A

MOTOR					
Type		Submersible oil filled (type OF)		Submersible water filled (type WF)	
Manufacturer		Sumoto			
		Single phase	Three phase	Single phase	Three phase
Power rating	[kW]	0.37÷3.7	0.37÷7.5	0.37÷3.7	0.37÷7.5
	[HP]	0.5÷5	0.5÷10	0.5÷5	0.5÷10
No. of Poles		2			
Rated speed		Refer to each characteristic performance rotation speed as rated speed			
Insulation class		F			
Protection degree		IP 58		IP 68	
Maximum temperature	[°C]	35			
Maximum immersion	[m]	150			
Starts / hours		30			
Start type		Direct on line			
Frequency	[Hz]	50 Hz			
Voltage	[V]	230(+6-10%)	400(+6-10%)	230(±6%)	400(±6%)
Capacitor for start and run		Fitted in starter box	-	Fitted in starter box	-
Over load protection		Fitted in starter box	Provided by the user	Fitted in starter box	Provided by the user
Sealing liquid		Oil type: Marcol 82 (Esso)		Propylene Glycol - water solution	
Motor bracket		Cast iron nickel plated		Cast iron G20	
Casing material		EN 1.4301 (AISI 304)			
Power cable	material	EPDM/Cross Seald Polyethylene			
	size [mm ²]	4x1.5			
	length [m]	L=1.75 (up to 2.2 kW) / L=2.5 (for 3 and 4 kW) / L=4 (for 5.5 and 7.5 kW)			
Flange mount		NEMA standard			

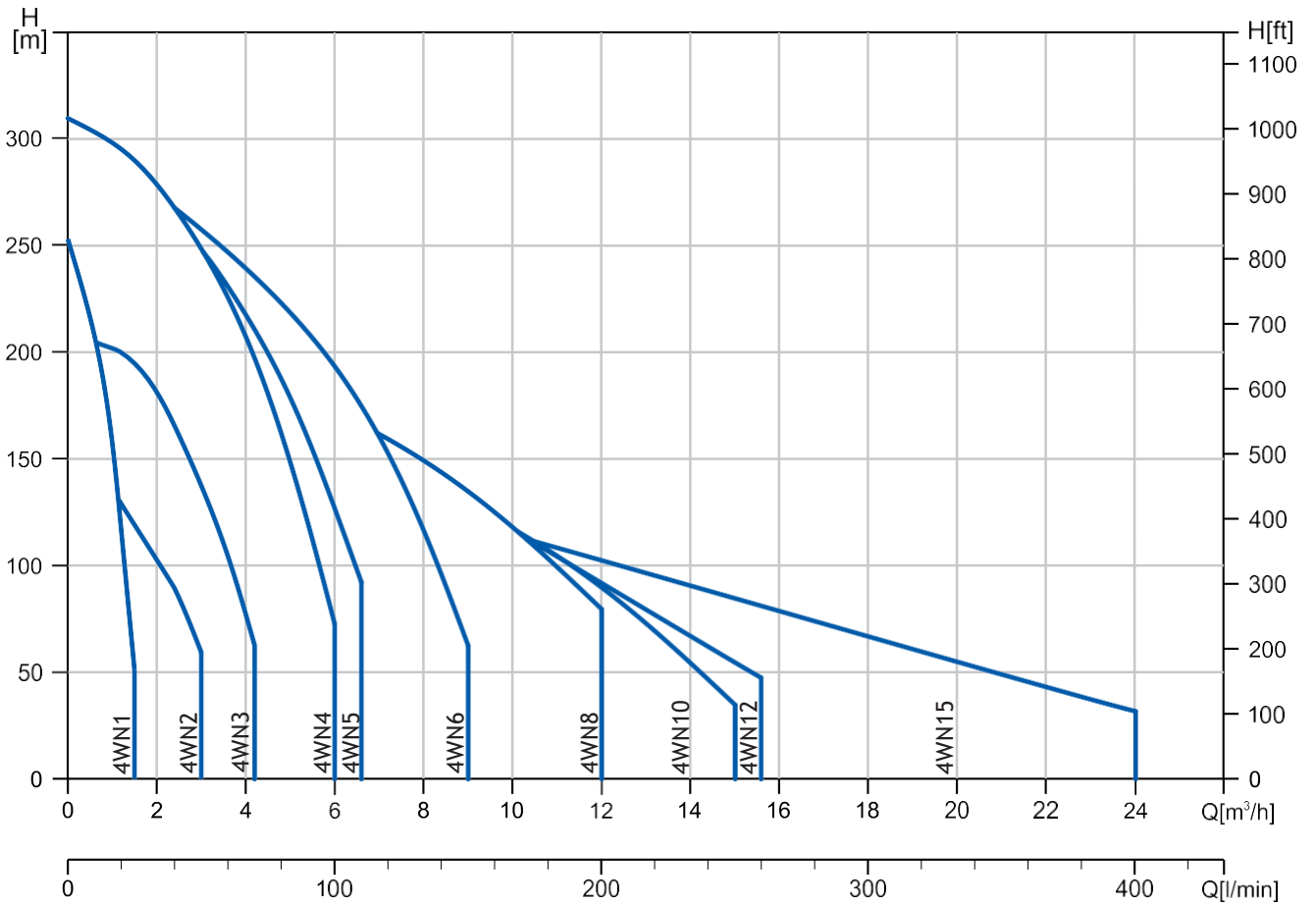

SUBMERSIBLE MULTISTAGE PUMPS

4WN

SELECTION CHART

50Hz

Rev. B

Type pumps	Power		Q=Capacity															
	[kW]	[HP]	l/min	5	10	15	20	25	30	35	40	45	50	60	70	80	90	100
			m³/h	0.3	0.6	0.9	1.2	1.5	1.8	2.1	2.4	2.7	3.0	3.6	4.2	4.8	5.4	6.0
H=Total manometric head in meters																		
4WN1-10	0.37	0.50	67	63	55	46	33	18	-	-	-	-	-	-	-	-	-	-
4WN1-13	0.37	0.50	86	78	70	56	42	23	-	-	-	-	-	-	-	-	-	-
4WN1-19	0.55	0.75	126	118	105	86	60	30	-	-	-	-	-	-	-	-	-	-
4WN1-26	0.75	1.00	173	160	141	117	81	39	-	-	-	-	-	-	-	-	-	-
4WN1-38	1.10	1.50	253	234	208	169	117	52	-	-	-	-	-	-	-	-	-	-
4WN2-5	0.37	0.50	34	-	-	32	31	29	27	25	23	19	16	-	-	-	-	-
4WN2-7	0.37	0.50	46	-	-	43	42	39	36	33	29	26	22	-	-	-	-	-
4WN2-10	0.55	0.75	67	-	-	64	61	58	54	49	43	36	28	-	-	-	-	-
4WN2-14	0.75	1.00	92	-	-	86	83	79	74	67	60	52	42	-	-	-	-	-
4WN2-20	1.10	1.50	139	-	-	131	127	120	111	101	90	75	60	-	-	-	-	-
4WN3-5	0.37	0.50	34	-	-	-	32	31	30	29	27	25	23	18	11	-	-	-
4WN3-8	0.55	0.75	54	-	-	-	51	50	49	46	43	41	38	30	19	-	-	-
4WN3-11	0.75	1.00	72	-	-	-	68	66	64	61	58	54	49	38	26	-	-	-
4WN3-16	1.10	1.50	106	-	-	-	101	98	95	89	83	77	70	54	33	-	-	-
4WN3-21	1.50	2.00	142	-	-	-	135	132	127	122	115	108	100	79	49	-	-	-
4WN3-32	2.20	3.00	208	-	-	-	200	194	187	177	165	152	138	104	62	-	-	-
4WN4-5	0.37	0.50	33	-	-	-	-	29	28	27	26	25	24	21	18	13	8	3
4WN4-7	0.55	0.75	46	-	-	-	-	43	42	41	39	38	36	33	28	22	15	7
4WN4-9	0.75	1.00	59	-	-	-	-	55	54	52	51	49	47	43	37	28	20	10
4WN4-14	1.10	1.50	93	-	-	-	-	87	86	83	81	79	76	68	58	47	33	20
4WN4-18	1.50	2.00	120	-	-	-	-	113	111	108	105	102	98	88	75	60	42	25
4WN4-27	2.20	3.00	175	-	-	-	-	164	161	157	152	147	141	127	109	87	61	35
4WN4-35	3.00	4.00	228	-	-	-	-	212	208	203	197	191	184	166	145	119	85	46
4WN4-44	3.70	5.00	282	-	-	-	-	261	255	249	241	233	223	201	173	140	99	52
4WN4-48	4.00	5.50	309	-	-	-	-	289	283	276	267	258	248	225	197	162	120	73
4WN5-4	0.37	0.50	26	-	-	-	-	-	-	23	22	22	21	19	17	14	11	7
4WN5-6	0.55	0.75	38	-	-	-	-	-	-	36	35	33	32	30	26	22	18	12
4WN5-8	0.75	1.00	51	-	-	-	-	-	-	47	46	44	43	39	35	30	24	18
4WN5-12	1.10	1.50	77	-	-	-	-	-	-	72	71	69	68	63	57	49	41	31
4WN5-16	1.50	2.00	102	-	-	-	-	-	-	98	96	94	92	86	77	68	57	46
4WN5-24	2.20	3.00	151	-	-	-	-	-	-	142	139	136	132	122	111	97	80	62
4WN5-32	3.00	4.00	203	-	-	-	-	-	-	188	185	180	175	162	146	127	105	80
4WN5-40	3.70	5.00	253	-	-	-	-	-	-	232	227	222	216	202	182	159	131	102
4WN5-44	4.00	5.50	278	-	-	-	-	-	-	265	260	254	247	230	210	187	159	127

Type pumps	Power		Q=Capacity																							
	[kW]	[HP]	l/min	45	50	60	70	80	90	100	120	140	160	180	200	220	240	260	280	300	320	340	360	380	400	
			m³/h	2.7	3.0	3.6	4.2	4.8	5.4	6.0	7.2	8.4	9.6	10.8	12.0	13.2	14.4	15.6	16.8	18.0	19.2	20.4	21.6	22.8	24.0	
H=Total manometric head in meters																										
4WN6-7	0.75	1.00	42	-	36	34	32	30	28	25	19	11	-	-	-	-	-	-	-	-	-	-	-	-	-	-
4WN6-10	1.10	1.50	62	-	53	51	48	45	41	38	29	18	-	-	-	-	-	-	-	-	-	-	-	-	-	-
4WN6-14	1.50	2.00	90	-	77	74	71	68	63	59	46	28	-	-	-	-	-	-	-	-	-	-	-	-	-	-
4WN6-20	2.20	3.00	125	-	107	102	97	92	86	80	62	40	-	-	-	-	-	-	-	-	-	-	-	-	-	-
4WN6-27	3.00	4.00	169	-	145	139	131	123	115	107	84	55	-	-	-	-	-	-	-	-	-	-	-	-	-	-
4WN6-34	3.70	5.00	208	-	178	170	162	153	143	132	103	66	-	-	-	-	-	-	-	-	-	-	-	-	-	-
4WN6-36	4.00	5.50	221	-	190	181	173	164	154	143	112	72	-	-	-	-	-	-	-	-	-	-	-	-	-	-
4WN6-49	5.50	7.50	302	-	257	246	234	222	209	193	151	96	-	-	-	-	-	-	-	-	-	-	-	-	-	-
4WN8-4	0.75	1.00	26	-	-	-	23	22	21	20	18	16	12	9	-	-	-	-	-	-	-	-	-	-	-	-
4WN8-6	1.10	1.50	38	-	-	-	35	34	33	31	28	24	19	14	-	-	-	-	-	-	-	-	-	-	-	-
4WN8-8	1.50	2.00	52	-	-	-	47	45	44	41	37	31	25	18	-	-	-	-	-	-	-	-	-	-	-	-
4WN8-13	2.20	3.00	82	-	-	-	75	73	71	66	59	50	40	30	-	-	-	-	-	-	-	-	-	-	-	-
4WN8-17	3.00	4.00	108	-	-	-	98	96	94	87	79	70	58	46	-	-	-	-	-	-	-	-	-	-	-	-
4WN8-21	3.70	5.00	132	-	-	-	117	114	111	103	93	82	68	52	-	-	-	-	-	-	-	-	-	-	-	-
4WN8-23	4.00	5.50	148	-	-	-	134	131	127	118	108	95	79	60	-	-	-	-	-	-	-	-	-	-	-	-
4WN8-32	5.50	7.50	202	-	-	-	182	178	172	160	143	125	105	80	-	-	-	-	-	-	-	-	-	-	-	-
4WN10-7	1.10	1.50	41	-	-	-	35	34	33	32	29	26	23	18	14	8	-	-	-	-	-	-	-	-	-	-
4WN10-10	1.50	2.00	58	-	-	-	49	48	47	44	41	37	32	27	20	13	-	-	-	-	-	-	-	-	-	-
4WN10-14	2.20	3.00	83	-	-	-	71	69	67	63	58	54	48	40	31	20	-	-	-	-	-	-	-	-	-	-
4WN10-18	3.00	4.00	107	-	-	-	92	90	87	83	77	70	62	52	39	26	-	-	-	-	-	-	-	-	-	-
4WN10-22	3.70	5.00	131	-	-	-	110	107	104	98	91	82	71	58	45	30	-	-	-	-	-	-	-	-	-	-
4WN10-24	4.00	5.50	141	-	-	-	118	116	113	106	97	88	77	63	49	33	-	-	-	-	-	-	-	-	-	-
4WN10-32	5.50	7.50	189	-	-	-	162	157	153	144	134	122	107	90	70	47	-	-	-	-	-	-	-	-	-	-
4WN12-7	1.50	2.00	45	-	-	-	-	37	36	33	31	28	25	22	18	14	-	-	-	-	-	-	-	-	-	-
4WN12-10	2.20	3.00	64	-	-	-	-	54	52	48	44	41	36	32	26	20	-	-	-	-	-	-	-	-	-	-
4WN12-14	3.00	4.00	89	-	-	-	-	76	72	67	62	56	49	43	35	28	-	-	-	-	-	-	-	-	-	-
4WN12-17	3.70	5.00	107	-	-	-	-	90	86	80	74	67	59	51	42	32	-	-	-	-	-	-	-	-	-	-
4WN12-19	4.00	5.50	120	-	-	-	-	102	97	91	89	76	68	58	48	37	-	-	-	-	-	-	-	-	-	-
4WN12-26	5.50	7.50	163	-	-	-	-	136	129	120	111	100	87	75	61	48	-	-	-	-	-	-	-	-	-	-
4WN12-38	7.50	10.00	239	-	-	-	-	202	192	182	168	150	133	115	95	70	-	-	-	-	-	-	-	-	-	-
4WN15-8	2.20	3.00	49	-	-	-	-	-	-	39	38	36	34	32	30	28	25	23	20	18	15	12	9	-	-	-
4WN15-11	3.00	4.00	67	-	-	-	-	-	-	55	53	50	48	45	42	39	36	33	30	27	23	20	16	-	-	-
4WN15-13	3.70	5.00	79	-	-	-	-	-	-	65	62	59	56	53	50	47	43	40	36	32	28	24	20	-	-	-
4WN15-15	4.00	5.50	93	-	-	-	-	-	-	76	73	70	66	62	59	55	51	47	43	39	34	29	25	-	-	-
4WN15-20	5.50	7.50	122	-	-	-	-	-	-	99	95	90	86	81	76	72	67	61	56	50	44	38	32	-	-	-
4WN15-26	7.50	10.00	158	-	-	-	-	-	-	128	122	115	111	105	100	95	90	85	80	72	67	61	56	49	-	-

TYPE KEY

EXAMPLE pump without motor

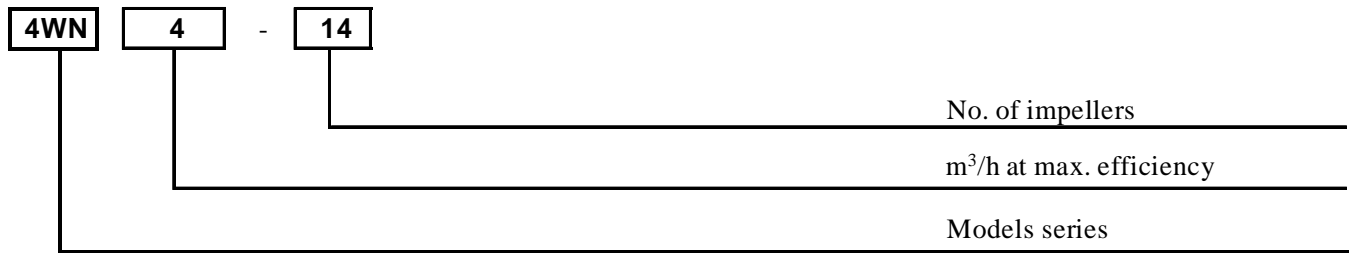

EXAMPLE pump with motor

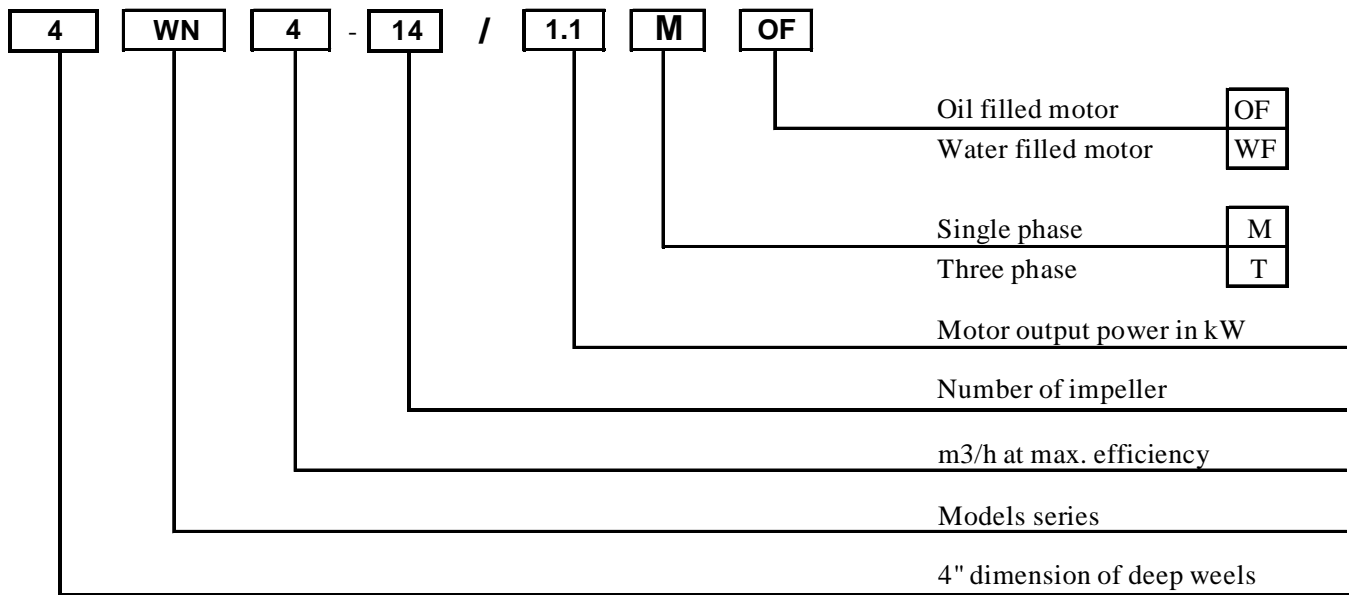

PERFORMANCE CURVE SPECIFICATIONS

The specifications below qualify the curves shown on the following pages.

Tolerances according to ISO 9906 Annex A

The curves refer to effective speed of asynchronous motors at 50 Hz

Measurements were carried out with clean water at 20°C of temperature and with a kinematic viscosity of $\nu = 1 \text{ mm}^2/\text{s}$ (1 cSt)

The continuous curves indicate the recommended working range. The dotted curve is only a guide.

In order to avoid the risk of over-heating, the pumps should not be used at a flow rate below 10% of best efficiency point.

Symbols explanation:

- Q = volume flow rate
- H = total head
- P_2 = pump power input (shaft power)
- η = pump efficiency
- NPSH = net positive suction head required by the pump
- MEI = minimum efficiency index

The minimum efficiency index (MEI) is a measure of the quality of a pump size in respect to its mean efficiency. The minimum efficiency index is based on the hydraulic efficiency and on the head at the best efficiency point.

The efficiency of a pump with trimmed impeller is usually lower than that of a pump with the full impeller diameter. The trimming of the impeller will adapt the pump to a fixed duty point, leading to reduced energy consumption. The minimum efficiency index (MEI) is based on the full impeller diameter.

The operation of these water pumps with variable duty points may be more efficient and economic when controlled, for example, by the use of a variable speed drive that matches the pump duty to the system.

MEI = 0.4 for Multistage Submersible 2900rpm

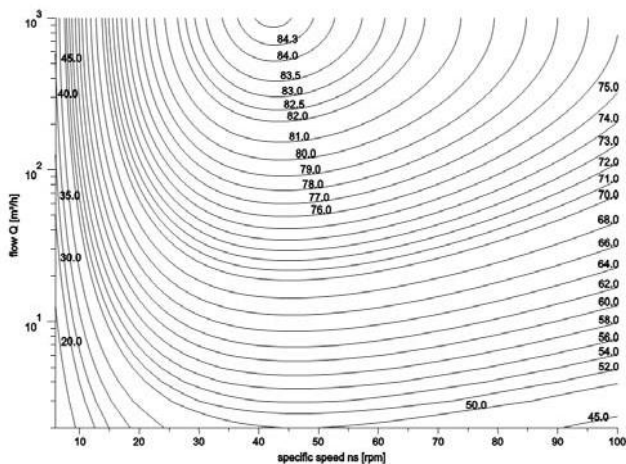

MEI = 0.7 for Multistage Submersible 2900 rpm

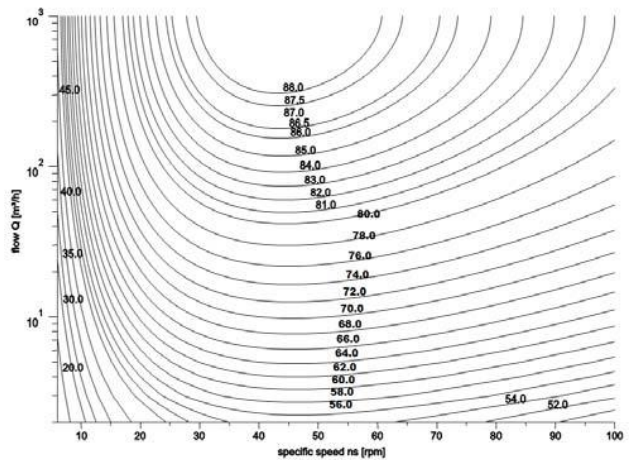

4WN1 – MEI > 0.70

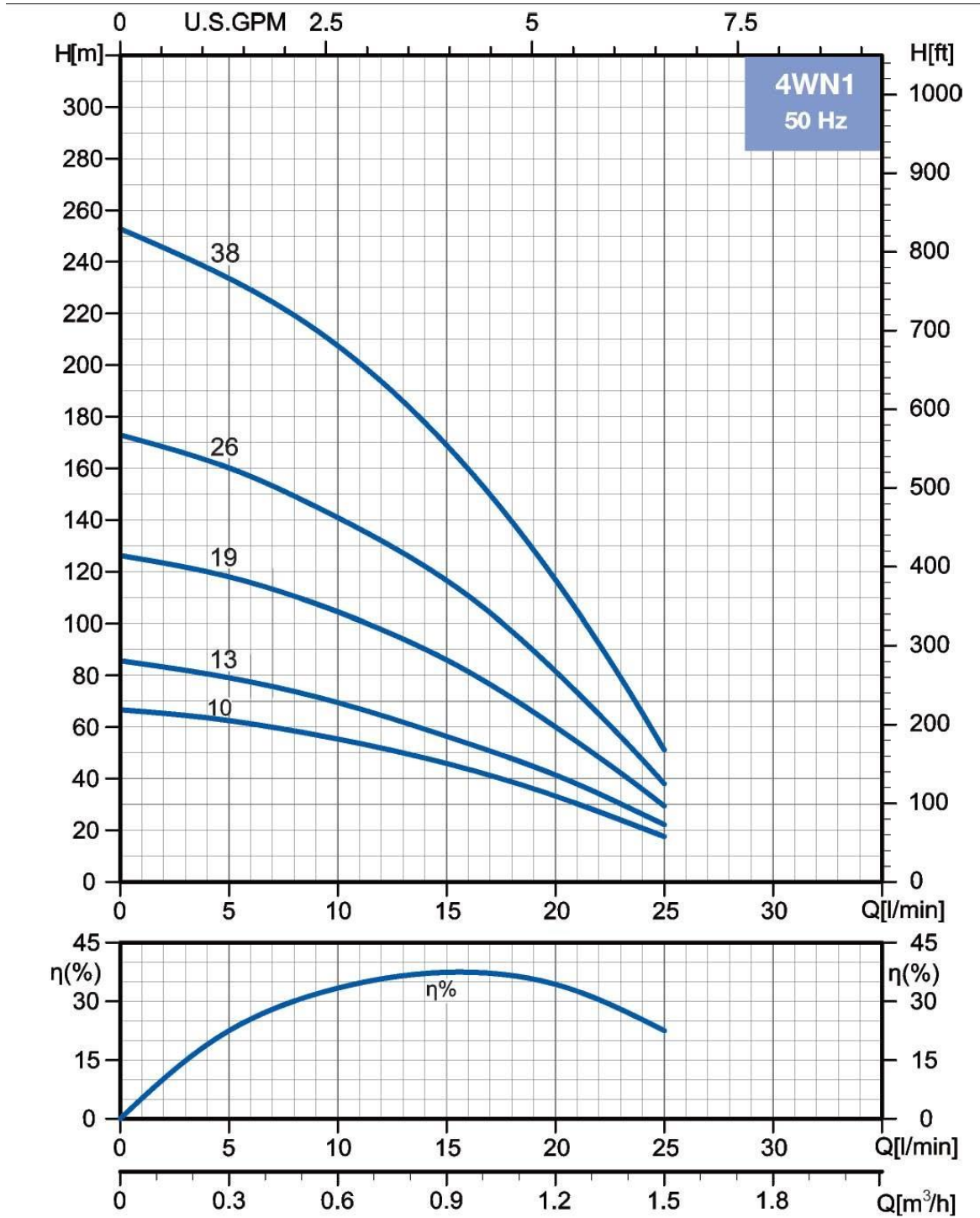

Rotation speed $\approx 2850 \text{ min}^{-1}$ Test
 standard: ISO 9906 – Annex A

4WN2 – MEI > 0.70

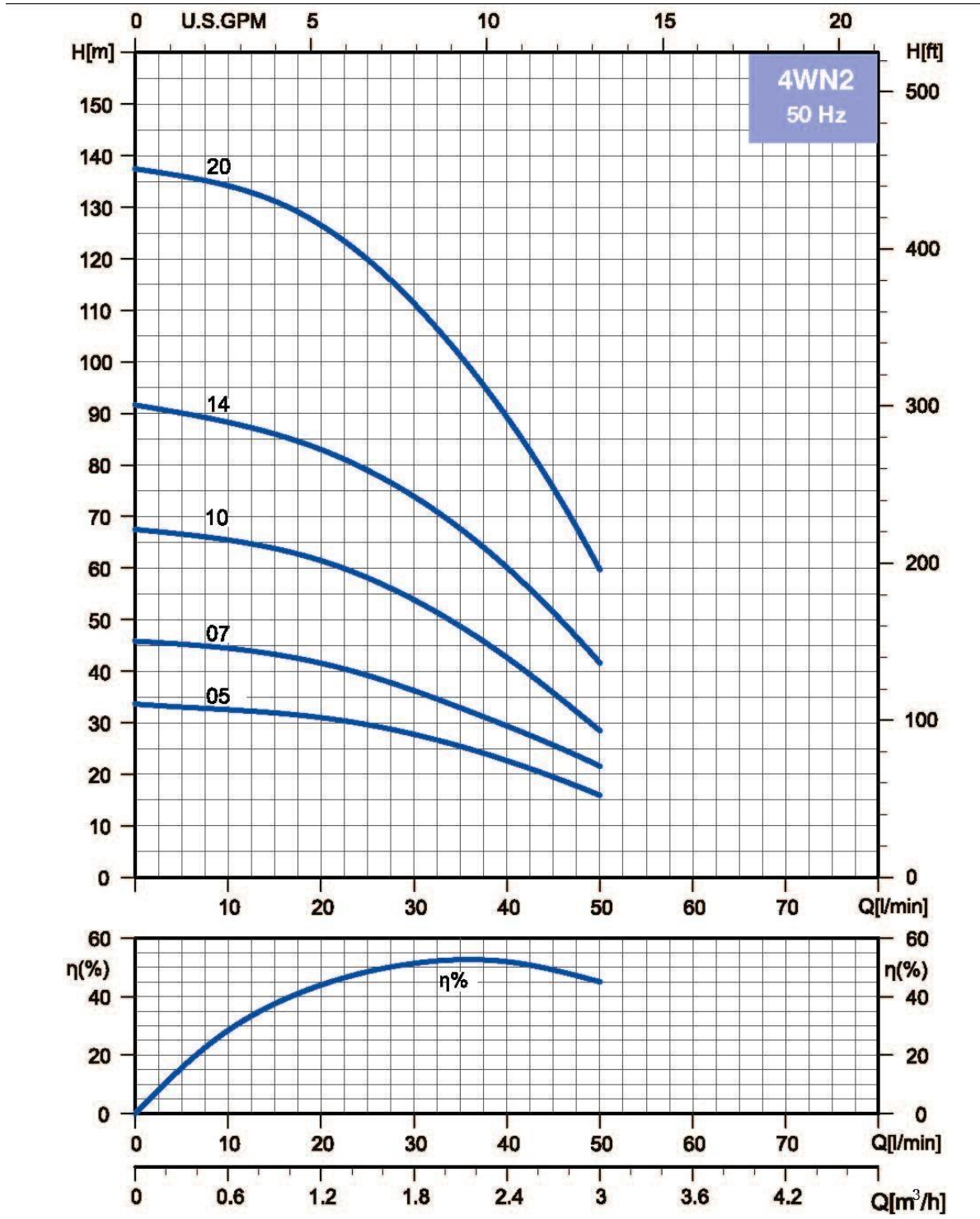

Rotation speed $\approx 2850 \text{ min}^{-1}$ Test
 standard: ISO 9906 – Annex A

4WN3 – MEI > 0.70

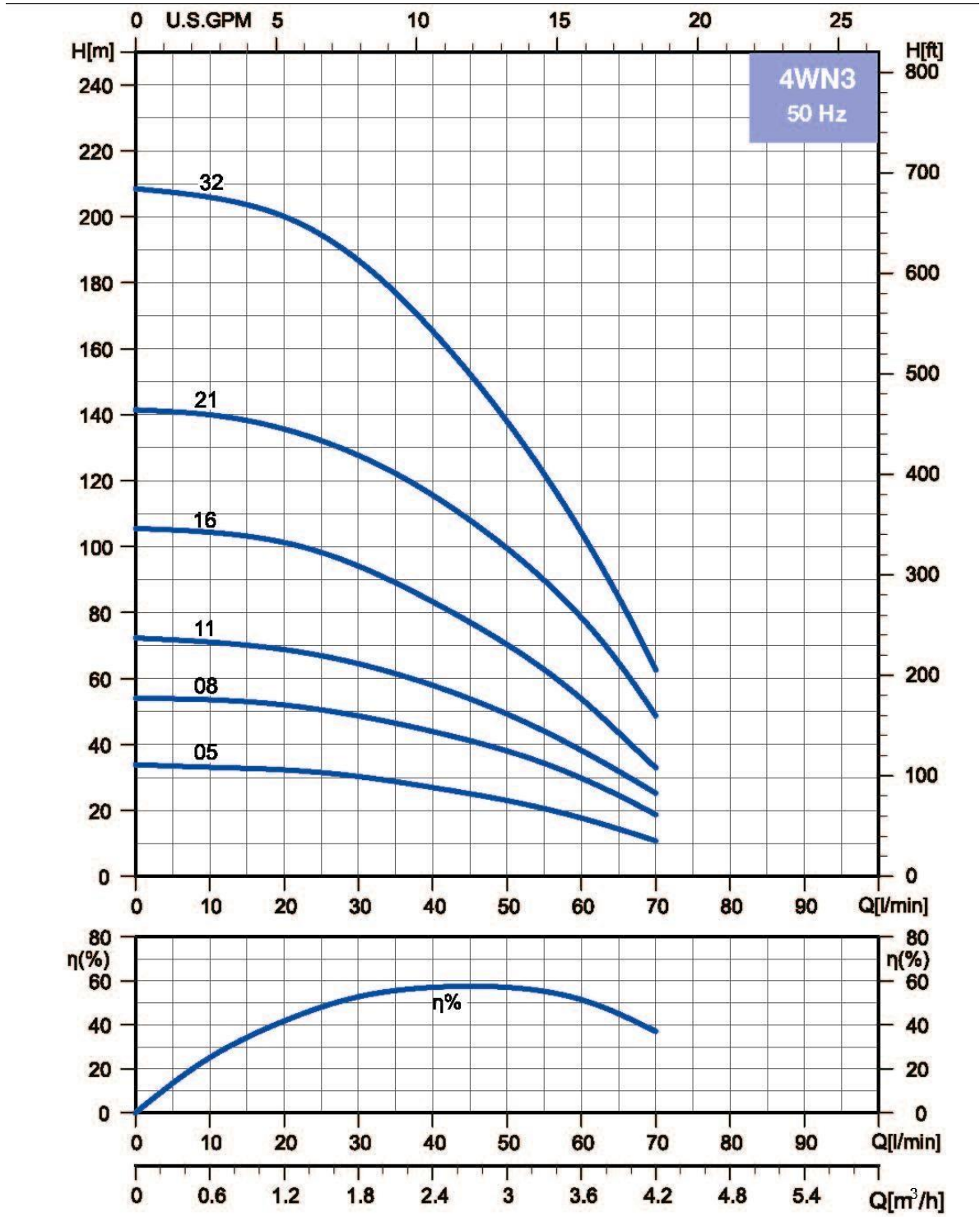

Rotation speed $\approx 2850 \text{ min}^{-1}$ Test
 standard: ISO 9906 – Annex A

4WN4 – MEI > 0.70

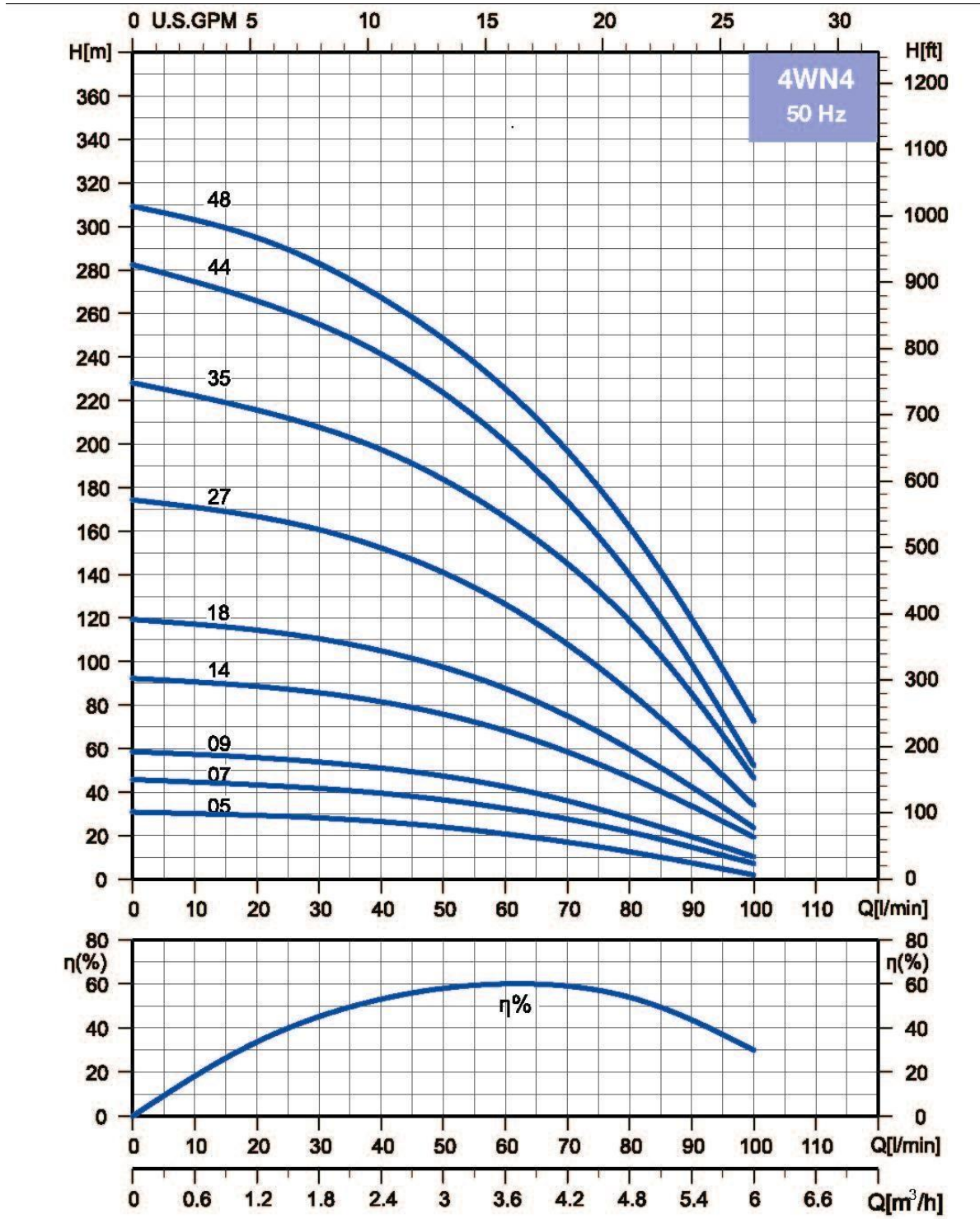

Rotation speed $\approx 2850 \text{ min}^{-1}$ Test
 standard: ISO 9906 – Annex A

4WN5 – MEI > 0.60

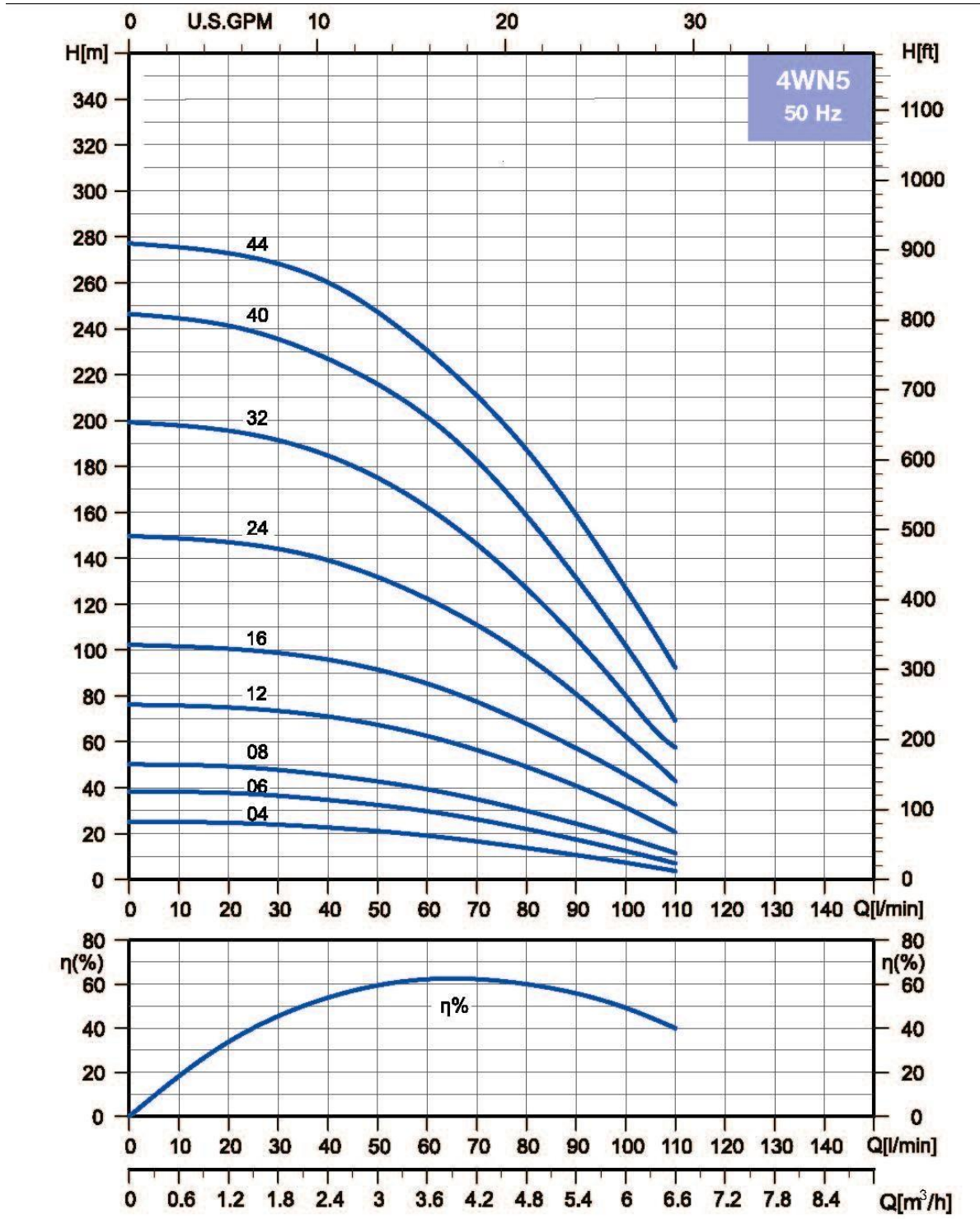

Rotation speed $\approx 2850 \text{ min}^{-1}$ Test
 standard: ISO 9906 – Annex A

4WN6 – MEI > 0.10

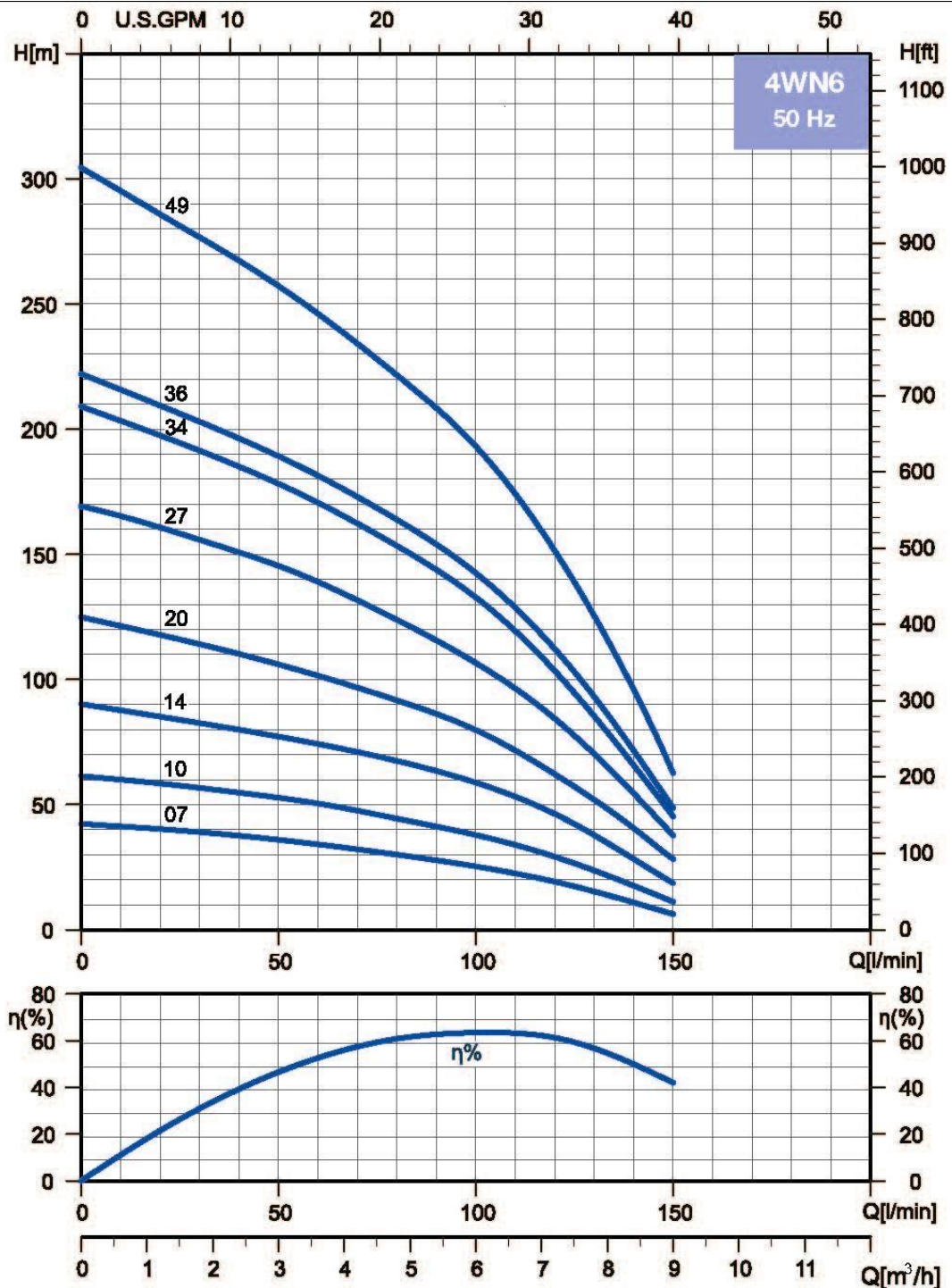

PRODUCT NOT AVAILABLE FOR THE EUROPEAN MARKET

Rotation speed $\approx 2850 \text{ min}^{-1}$ Test
 standard: ISO 9906 – Annex A

4WN8 – MEI > 0.10

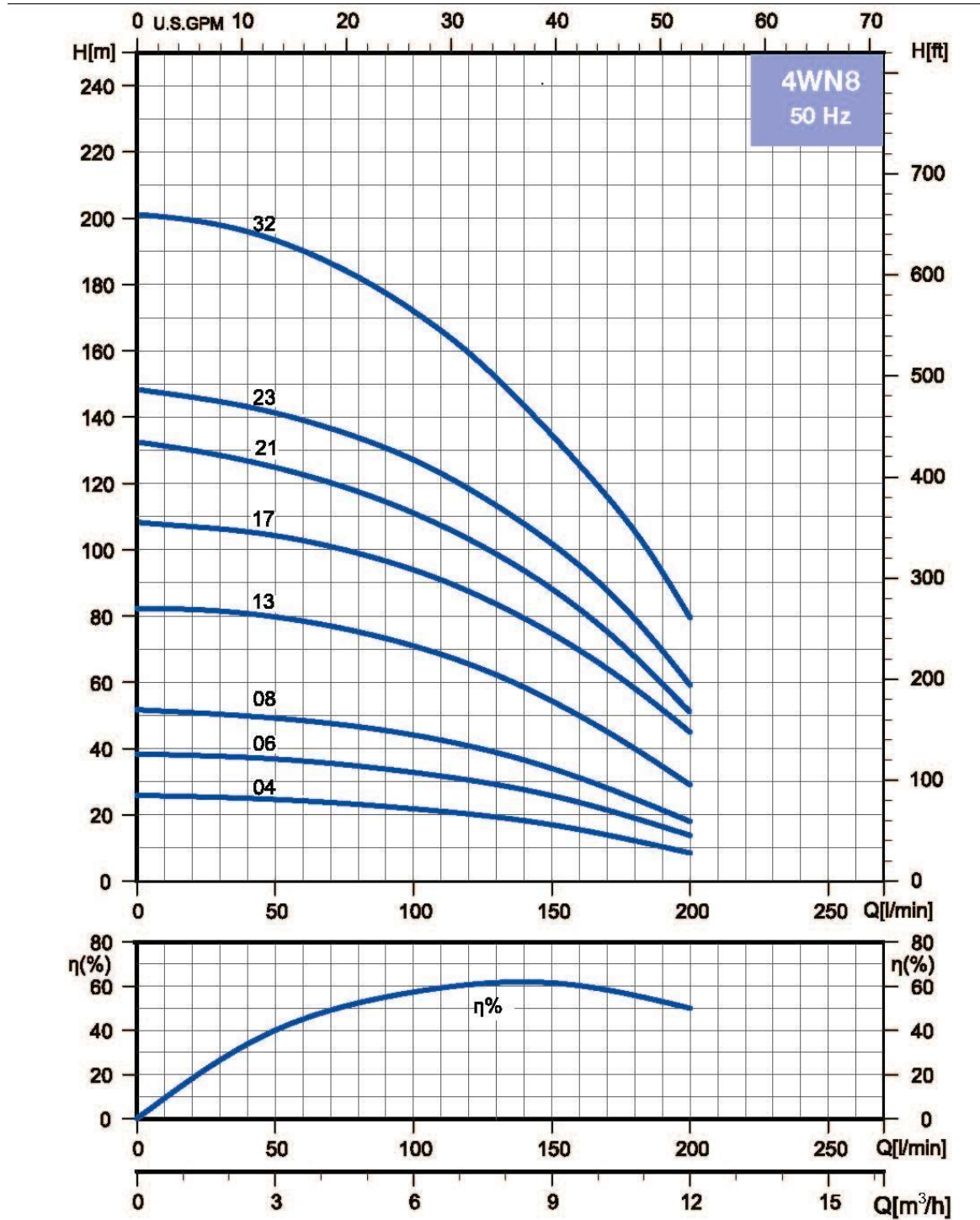

PRODUCT NOT AVAILABLE FOR THE EUROPEAN MARKET

Rotation speed $\approx 2850 \text{ min}^{-1}$ Test
 standard: ISO 9906 – Annex A

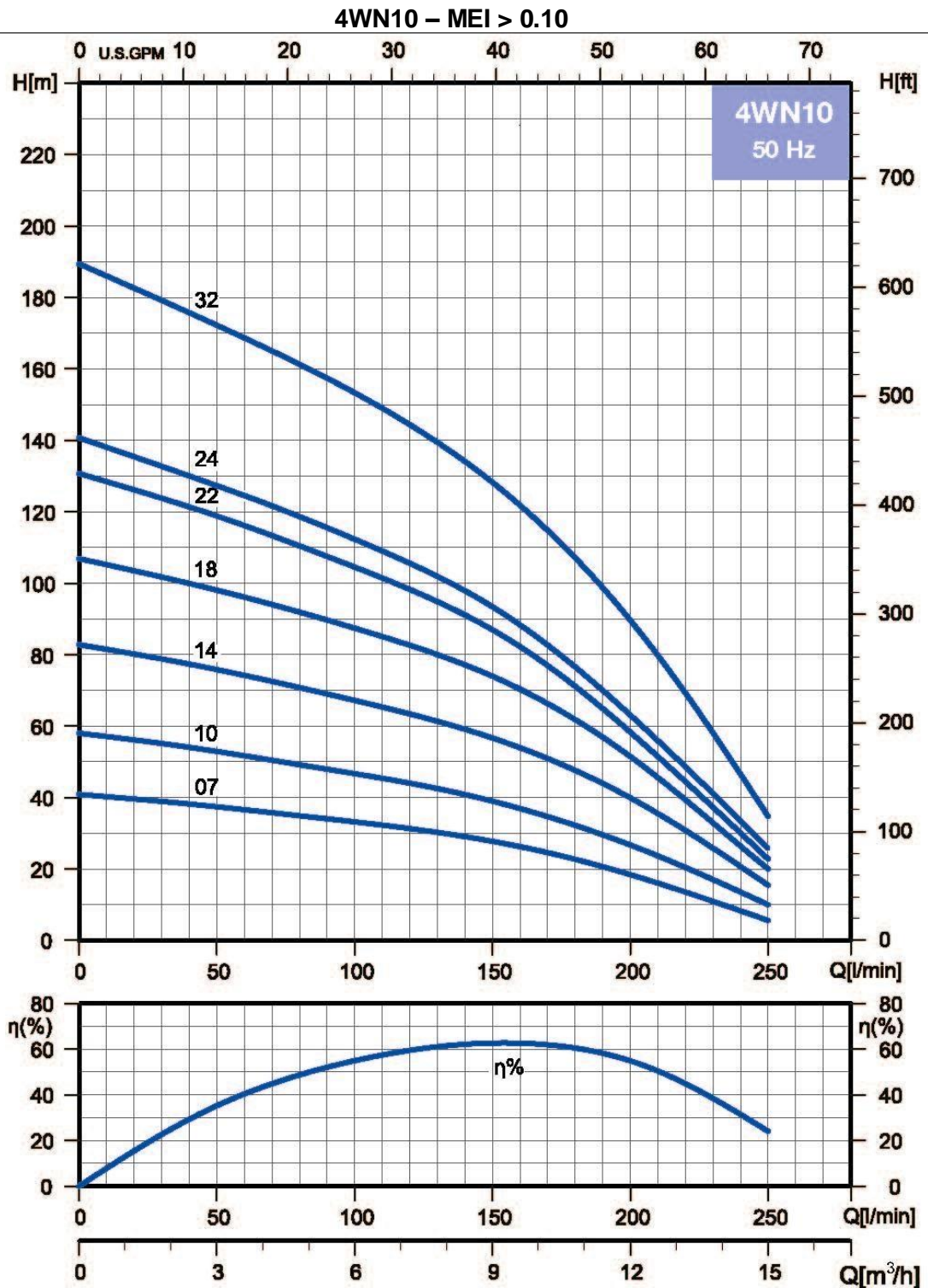

PRODUCT NOT AVAILABLE FOR THE EUROPEAN MARKET

Rotation speed $\approx 2850 \text{ min}^{-1}$ Test
 standard: ISO 9906 – Annex A

4WN12 – MEI > 0.10

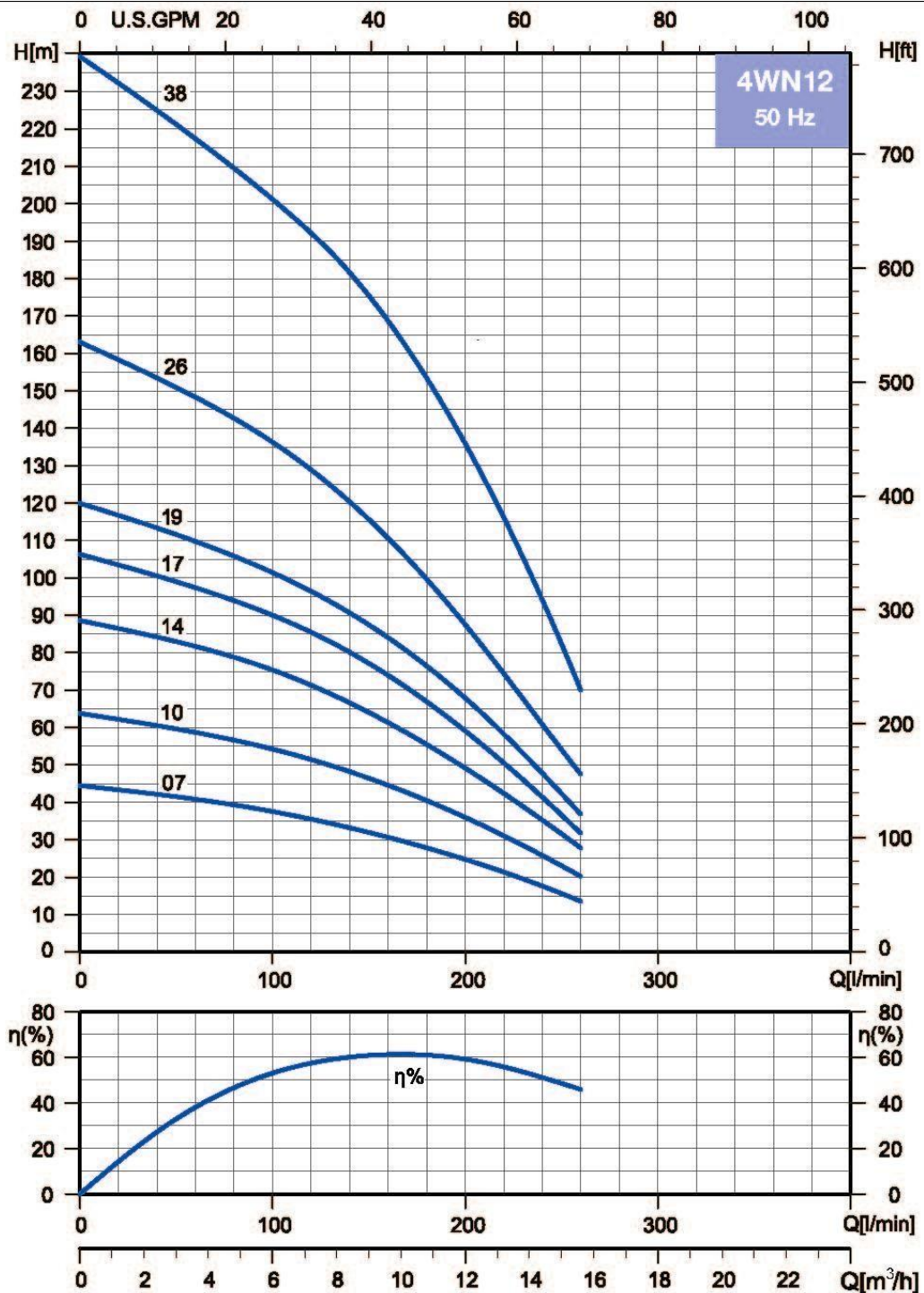

PRODUCT NOT AVAILABLE FOR THE EUROPEAN MARKET

Rotation speed $\approx 2850 \text{ min}^{-1}$ Test
 standard: ISO 9906 – Annex A

4WN15 – MEI > 0.10

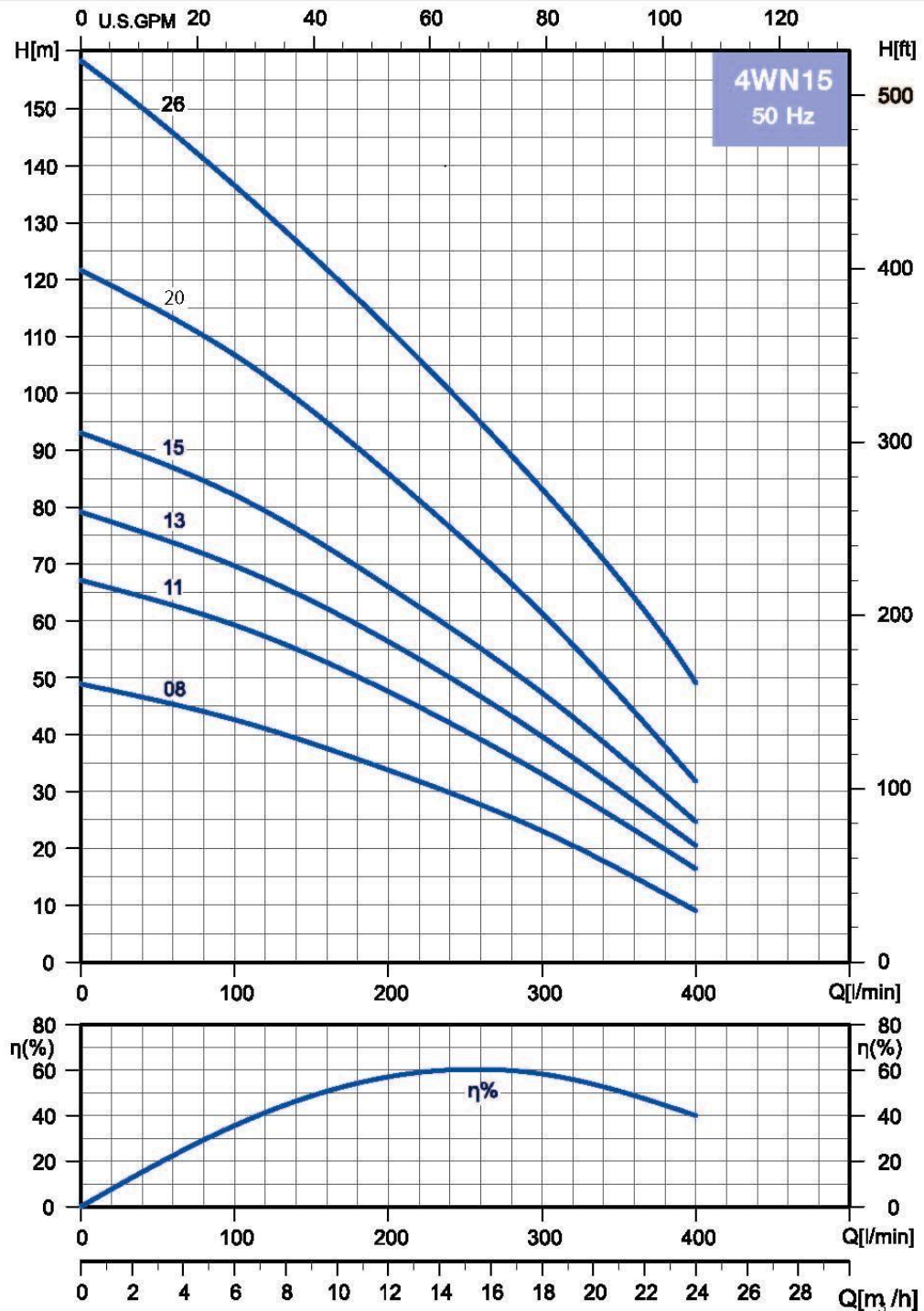

PRODUCT NOT AVAILABLE FOR THE EUROPEAN MARKET

Rotation speed $\approx 2850 \text{ min}^{-1}$ Test
 standard: ISO 9906 – Annex A

SECTIONAL VIEW

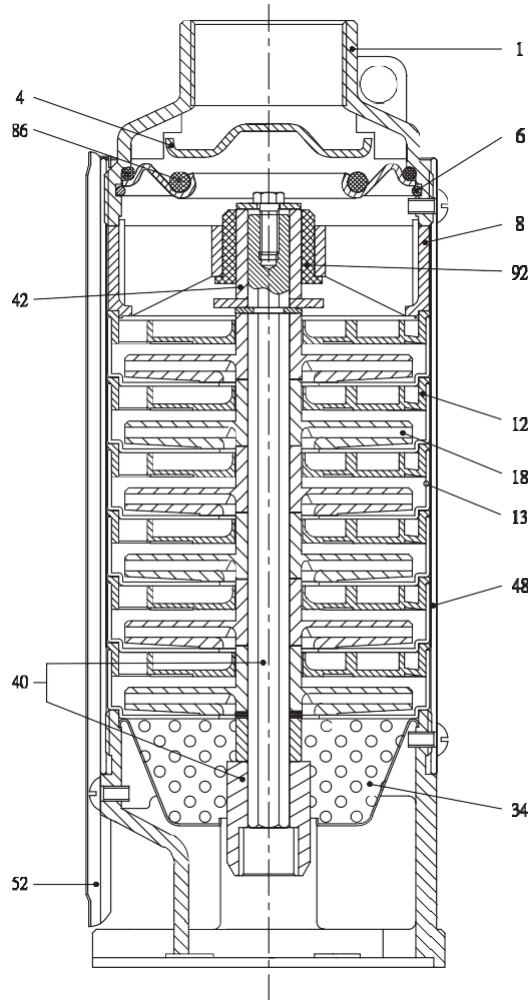

N°	PART NAME	MATERIAL
1	Discharge Head	AISI 304 SS
4	Check Valve Cone	AISI 304 SS
6	Check Valve retaining ring	AISI 304 SS
8	Bearing Spider	Glass Filled Polycarbonate
12	Diffuser	Glass Filled Polycarbonate
13	Bowl	AISI 304 SS
18	Impeller	Noryl34
34	Strainer	AISI 304 SS
40	Pump Shaft/Coupling	AISI 304 SS
42	Shaft Sleeve	AISI 304 SS or Noryl
48	Pump casing	AISI 304 SS
52	Cable Guard	AISI 304 SS
86	O-Ring	NBR
92	Bearing	Polyacetal

PUMP

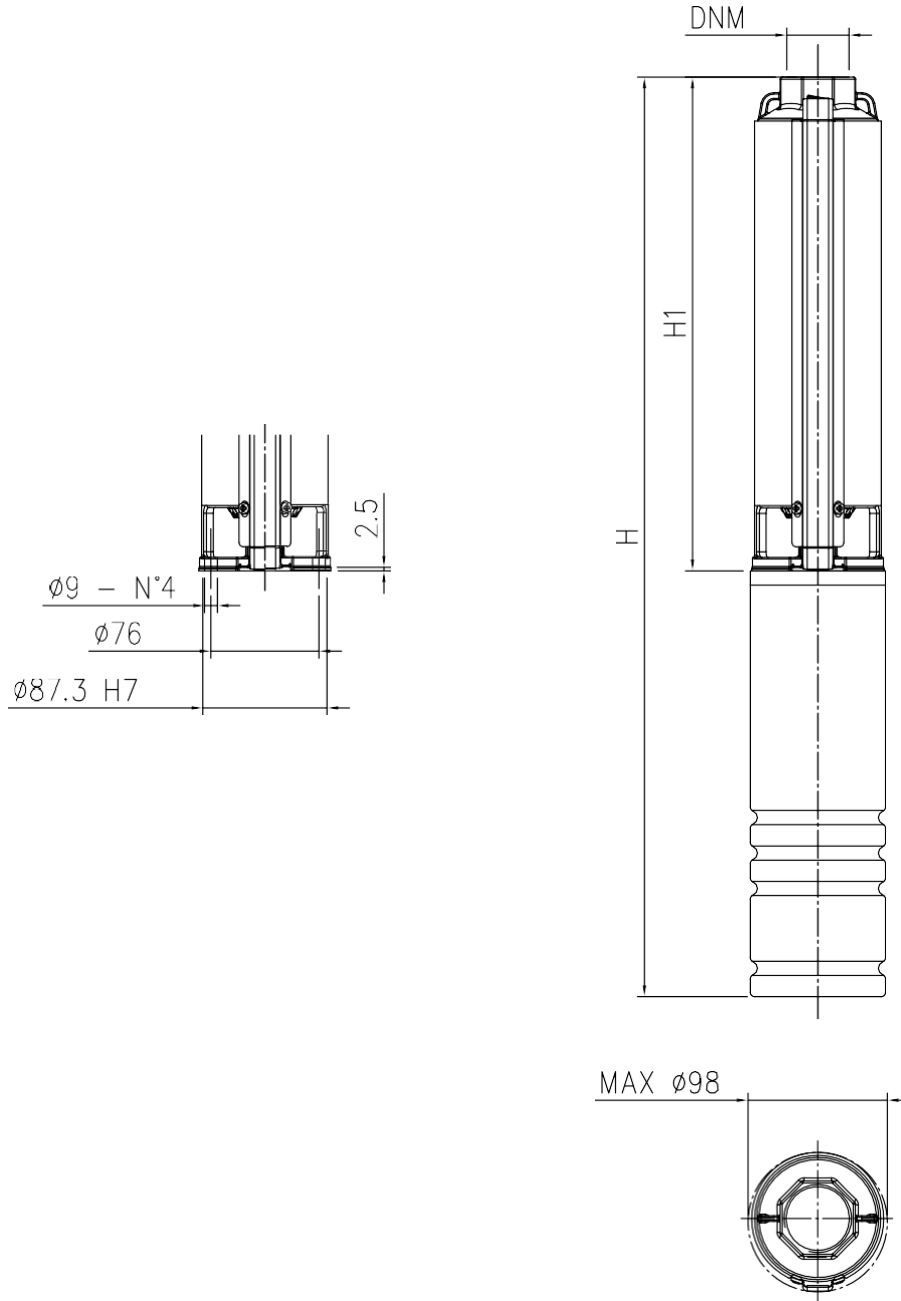

Pump can be coupled with NEMA standard 4" motor

Type	Power		H1	DNM	H (OIL motor version)		H (Water motor version)	
	[kW]	[HP]			<i>single-phase</i>	<i>three-phase</i>	<i>single-phase</i>	<i>three-phase</i>
4WN1-10	0.37	0.50	324	1 1/4	649	649	574	559
4WN1-13	0.37	0.50	377	1 1/4	702	702	627	612
4WN1-19	0.55	0.75	481	1 1/4	806	806	731	731
4WN1-26	0.75	1.00	642	1 1/4	992	967	937	937
4WN1-38	1.10	1.50	864	1 1/4	1249	1214	1204	1204
4WN2-5	0.37	0.50	236	1 1/4	561	561	486	471
4WN2-7	0.37	0.50	271	1 1/4	596	596	521	506
4WN2-10	0.55	0.75	324	1 1/4	649	649	574	574
4WN2-14	0.75	1.00	394	1 1/4	744	719	689	689
4WN2-20	1.10	1.50	499	1 1/4	884	849	839	839
4WN3-5	0.37	0.50	236	1 1/4	561	561	486	471
4WN3-8	0.55	0.75	289	1 1/4	614	614	539	539
4WN3-11	0.75	1.00	342	1 1/4	692	667	637	637
4WN3-16	1.10	1.50	430	1 1/4	815	780	770	770
4WN3-21	1.50	2.00	519	1 1/4	939	904	894	894
4WN3-32	2.20	3.00	749	1 1/4	1219	1169	1179	1179
4WN4-5	0.37	0.50	257	1 1/4	582	582	507	492
4WN4-7	0.55	0.75	301	1 1/4	626	626	551	551
4WN4-9	0.75	1.00	344	1 1/4	694	669	639	639
4WN4-14	1.10	1.50	452	1 1/4	837	802	792	792
4WN4-18	1.50	2.00	538	1 1/4	958	923	913	913
4WN4-27	2.20	3.00	767	1 1/4	1237	1187	1197	1197
4WN4-35	3.00	4.00	934	1 1/4	-	1352	-	1414
4WN4-44	3.70	5.00	1128	1 1/4	-	1596	-	1683
4WN4-48	4.00	5.50	1253	1 1/4	-	1721	-	1808
4WN5-4	0.37	0.50	247	1 1/2	572	572	497	482
4WN5-6	0.55	0.75	296	1 1/2	621	621	546	546
4WN5-8	0.75	1.00	345	1 1/2	695	670	640	640
4WN5-12	1.10	1.50	433	1 1/2	818	783	773	773
4WN5-16	1.50	2.00	542	1 1/2	962	927	917	917
4WN5-24	2.20	3.00	777	1 1/2	1247	1197	1207	1207
4WN5-32	3.00	4.00	965	1 1/2	-	1383	-	1445
4WN5-40	3.70	5.00	1160	1 1/2	-	1628	-	1715
4WN5-44	4.00	5.50	1296	1 1/2	-	1764	-	1851

Type	Power		H1	DNM	H (OIL motor version)		H (Water motor version)	
	[kW]	[HP]			<i>single-phase</i>	<i>three-phase</i>	<i>single-phase</i>	<i>three-phase</i>
4WN6-7	0.75	1.00	390	2	740	715	685	685
4WN6-10	1.10	1.50	483	2	868	833	823	823
4WN6-14	1.50	2.00	607	2	1027	992	982	982
4WN6-20	2.20	3.00	831	2	1301	1251	1261	1261
4WN6-27	3.00	4.00	1048	2	-	1466	-	1528
4WN6-34	3.70	5.00	1257	2	-	1725	-	1812
4WN6-36	4.00	5.50	1318	2	-	1786	-	1873
4WN6-49	5.50	7.50	1802	2	-	2340	-	2477
4WN8-4	0.75	1.00	294	2	644	619	589	589
4WN8-6	1.10	1.50	356	2	741	706	696	696
4WN8-8	1.50	2.00	418	2	838	803	793	793
4WN8-13	2.20	3.00	573	2	1043	993	1003	1003
4WN8-17	3.00	4.00	697	2	-	1115	-	1177
4WN8-21	3.70	5.00	859	2	-	1327	-	1414
4WN8-23	4.00	5.50	921	2	-	1389	-	1476
4WN8-32	5.50	7.50	1238	2	-	1776	-	1913
4WN10-7	1.10	1.50	537	2	922	887	877	877
4WN10-10	1.50	2.00	693	2	1113	1078	1068	1068
4WN10-14	2.20	3.00	901	2	1371	1321	1331	1331
4WN10-18	3.00	4.00	1147	2	-	1565	-	1627
4WN10-22	3.70	5.00	1345	2	-	1813	-	1900
4WN10-24	4.00	5.50	1449	2	-	1917	-	2004
4WN10-32	5.50	7.50	1866	2	-	2404	-	2541
4WN12-7	1.50	2.00	534	2	954	919	909	909
4WN12-10	2.20	3.00	690	2	1160	1110	1120	1120
4WN12-14	3.00	4.00	989	2	-	1407	-	1469
4WN12-17	3.70	5.00	1092	2	-	1560	-	1647
4WN12-19	4.00	5.50	1195	2	-	1663	-	1750
4WN12-26	5.50	7.50	1559	2	-	2097	-	2234
4WN12-38	7.50	10.00	2380	2	-	3190	-	3145
4WN15-8	2.20	3.00	676	2	1146	1096	1106	1106
4WN15-11	3.00	4.00	880	2	-	1298	-	1360
4WN15-13	3.70	5.00	1013	2	-	1481	-	1568
4WN15-15	4.00	5.50	1149	2	-	1617	-	1704
4WN15-20	5.50	7.50	1489	2	-	2027	-	2164
4WN15-26	7.50	10.00	2020	2	-	2830	-	2785

			Weight [kg] - Oil motor version			Weight [kg] - Water motor version		
Type	Power		Pump	Pump + Motor		Pump	Pump + Motor	
	[kW]	[HP]		<i>single-phase</i>	<i>three-phase</i>		<i>single-phase</i>	<i>three-phase</i>
4WN1-10	0.37	0.50	3.3	10.3	9.8	3.3	10.1	9.1
4WN1-13	0.37	0.50	3.7	10.7	10.2	3.7	10.5	9.5
4WN1-19	0.55	0.75	4.7	12.3	11.7	4.7	12.8	12.8
4WN1-26	0.75	1.00	5.8	14.5	13.4	5.8	16.4	16.4
4WN1-38	1.10	1.50	8.2	18.5	16.9	8.2	19.4	19.4
4WN2-5	0.37	0.50	2.5	9.5	9	2.5	9.3	8.3
4WN2-7	0.37	0.50	2.8	9.8	9.3	2.8	9.6	8.6
4WN2-10	0.55	0.75	3.3	10.9	10.3	3.3	11.4	11.4
4WN2-14	0.75	1.00	3.9	12.6	11.5	3.9	14.5	14.5
4WN2-20	1.10	1.50	4.9	15.2	13.6	4.9	16.1	16.1
4WN3-5	0.37	0.50	2.5	9.5	9	2.5	9.3	8.3
4WN3-8	0.55	0.75	2.9	10.5	9.9	2.9	11	11
4WN3-11	0.75	1.00	3.4	12.1	11	3.4	14	14
4WN3-16	1.10	1.50	4.2	14.5	12.9	4.2	15.4	15.4
4WN3-21	1.50	2.00	5.0	17	15.4	5.0	19	19
4WN3-32	2.20	3.00	7.1	21.3	19.1	7.1	23.5	23.5
4WN4-5	0.37	0.50	2.7	9.7	9.2	2.7	9.5	8.5
4WN4-7	0.55	0.75	3.0	10.6	10	3.0	11.1	11.1
4WN4-9	0.75	1.00	3.3	12	10.9	3.3	13.9	13.9
4WN4-14	1.10	1.50	4.1	14.4	12.8	4.1	15.3	15.3
4WN4-18	1.50	2.00	4.7	16.7	15.1	4.7	18.7	18.7
4WN4-27	2.20	3.00	6.2	20.4	18.2	6.2	22.6	22.6
4WN4-35	3.00	4.00	7.9	-	21	7.9	-	26.2
4WN4-44	3.70	5.00	9.3	-	24.9	9.3	-	32.7
4WN4-48	4.00	5.50	9.9	-	25.5	9.9	-	33.3
4WN5-4	0.37	0.50	2.4	9.4	8.9	2.4	9.2	8.2
4WN5-6	0.55	0.75	2.9	10.5	9.9	2.9	11	11
4WN5-8	0.75	1.00	3.3	12	10.9	3.3	13.9	13.9
4WN5-12	1.10	1.50	4.1	14.4	12.8	4.1	15.3	15.3
4WN5-16	1.50	2.00	5.0	17	15.4	5.0	19	19
4WN5-24	2.20	3.00	6.6	20.8	18.6	6.6	23	23
4WN5-32	3.00	4.00	8.7	-	21.8	8.7	-	27
4WN5-40	3.70	5.00	10.4	-	26	10.4	-	33.8
4WN5-44	4.00	5.50	11.2	-	26.8	11.2	-	34.6

			Weight [kg] - Oil motor version			Weight [kg] - Water motor version		
Type	Power		Pump	Pump + Motor		Pump	Pump + Motor	
	[kW]	[HP]		<i>single-phase</i>	<i>three-phase</i>		<i>single-phase</i>	<i>three-phase</i>
4WN6-7	0.75	1.00	3.7	12.4	11.3	3.7	14.3	14.3
4WN6-10	1.10	1.50	4.6	14.9	13.3	4.6	15.8	15.8
4WN6-14	1.50	2.00	5.7	17.7	16.1	5.7	19.7	19.7
4WN6-20	2.20	3.00	7.5	21.7	19.5	7.5	23.9	23.9
4WN6-27	3.00	4.00	9.6	-	22.7	9.6	-	27.9
4WN6-34	3.70	5.00	11.6	-	27.2	11.6	-	35
4WN6-36	4.00	5.50	12.2	-	27.8	12.2	-	35.6
4WN6-49	5.50	7.50	15.9	-	34.8	15.9	-	45.3
4WN8-4	0.75	1.00	2.8	11.5	10.4	2.8	13.4	13.4
4WN8-6	1.10	1.50	3.4	13.7	12.1	3.4	14.6	14.6
4WN8-8	1.50	2.00	4.0	16	14.4	4.0	18	18
4WN8-13	2.20	3.00	5.5	19.7	17.5	5.5	21.9	21.9
4WN8-17	3.00	4.00	6.6	-	19.7	6.6	-	24.9
4WN8-21	3.70	5.00	7.8	-	23.4	7.8	-	31.2
4WN8-23	4.00	5.50	8.4	-	24	8.4	-	31.8
4WN8-32	5.50	7.50	11	-	29.9	11	-	40.4
4WN10-7	1.10	1.50	5.3	15.6	14	5.3	16.5	16.5
4WN10-10	1.50	2.00	6.7	18.7	17.1	6.7	20.7	20.7
4WN10-14	2.20	3.00	8.5	22.7	20.5	8.5	24.9	24.9
4WN10-18	3.00	4.00	10.4	-	23.5	10.4	-	28.7
4WN10-22	3.70	5.00	12.3	-	27.9	12.3	-	35.7
4WN10-24	4.00	5.50	13.2	-	28.8	13.2	-	36.6
4WN10-32	5.50	7.50	17	-	35.9	17	-	46.4
4WN12-7	1.50	2.00	5.3	17.3	15.7	5.3	19.3	19.3
4WN12-10	2.20	3.00	6.7	20.9	18.7	6.7	23.1	23.1
4WN12-14	3.00	4.00	8.6	-	21.7	8.6	-	26.9
4WN12-17	3.70	5.00	10.1	-	25.7	10.1	-	33.5
4WN12-19	4.00	5.50	11.0	-	26.6	11.0	-	34.4
4WN12-26	5.50	7.50	14.3	-	33.2	14.3	-	43.7
4WN12-38	7.50	10.00	18.8	-	45.8	18.8	-	52.6
4WN15-8	2.20	3.00	6.3	20.5	18.3	6.3	22.7	22.7
4WN15-11	3.00	4.00	8.1	-	21.2	8.1	-	26.4
4WN15-13	3.70	5.00	9.3	-	24.9	9.3	-	32.7
4WN15-15	4.00	5.50	10.5	-	26.1	10.5	-	33.9
4WN15-20	5.50	7.50	13.5	-	32.4	13.5	-	42.9
4WN15-26	7.50	10.00	-	-	44.1	-	-	50.8

PACKING

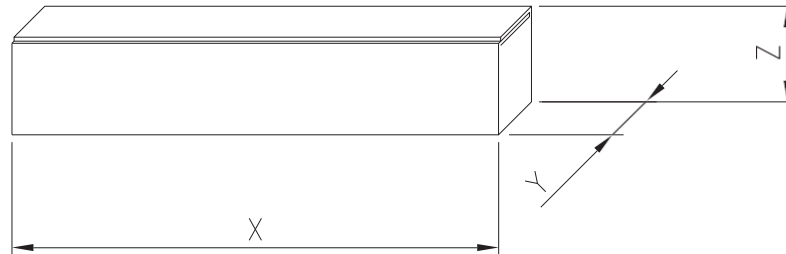

Type	Power		Packing [mm]			Weight [kgf]
	[kW]	[HP]	X	Y	Z	
4WN1-10	0.37	0.50	390	110	110	3.57
4WN1-13	0.37	0.50	450	110	110	4.00
4WN1-19	0.55	0.75	520	110	110	5.10
4WN1-26	0.75	1.00	690	110	110	6.74
4WN1-38	1.10	1.50	990	115	120	8.80
4WN2-5	0.37	0.50	290	110	110	2.70
4WN2-7	0.37	0.50	330	110	110	3.03
4WN2-10	0.55	0.75	390	110	110	3.57
4WN2-14	0.75	1.00	450	110	110	4.20
4WN2-20	1.10	1.50	555	110	110	5.24
4WN3-5	0.37	0.50	290	110	110	2.70
4WN3-8	0.55	0.75	330	110	110	3.13
4WN3-11	0.75	1.00	390	110	110	3.67
4WN3-16	1.10	1.50	480	110	110	4.50
4WN3-21	1.50	2.00	555	110	110	5.50
4WN3-32	2.20	3.00	870	115	120	7.82
4WN4-5	0.37	0.50	290	110	110	2.90
4WN4-7	0.55	0.75	330	110	110	3.23
4WN4-9	0.75	1.00	390	110	110	3.57
4WN4-14	1.10	1.50	520	110	110	4.42
4WN4-18	1.50	2.00	580	110	110	5.06
4WN4-27	2.20	3.00	870	115	120	6.92
4WN4-35	3.00	4.00	1060	115	120	8.73
4WN4-44	3.70	5.00	1280	115	120	10.25
4WN4-48	4.00	5.50	1390	115	120	10.90
4WN5-4	0.37	0.50	290	110	110	2.60
4WN5-6	0.55	0.75	330	110	110	3.13
4WN5-8	0.75	1.00	390	110	110	3.57
4WN5-12	1.10	1.50	480	110	110	4.40
4WN5-16	1.50	2.00	580	110	110	5.36
4WN5-24	2.20	3.00	870	115	120	7.32
4WN5-32	3.00	4.00	1090	115	120	9.55
4WN5-40	3.70	5.00	1280	115	120	11.35
4WN5-44	4.00	5.50	1420	115	120	12.20

Type	Power		Packing [mm]			Weight [kgf]
	[kW]	[HP]	X	Y	Z	
4WN6-7	0.75	1.00	450	110	110	4.00
4WN6-10	1.10	1.50	520	110	110	4.82
4WN6-14	1.50	2.00	660	110	110	6.10
4WN6-20	2.20	3.00	930	115	120	8.27
4WN6-27	3.00	4.00	1150	115	120	10.47
4WN6-34	3.70	5.00	1390	115	120	12.60
4WN6-36	4.00	5.50	145	115	120	13.30
4WN6-49	5.50	7.50	1930	115	120	17.25
4WN8-4	0.75	1.00	330	110	110	3.03
4WN8-6	1.10	1.50	390	110	110	3.67
4WN8-8	1.50	2.00	480	110	110	4.30
4WN8-13	2.20	3.00	660	110	110	5.90
4WN8-17	3.00	4.00	770	110	110	7.08
4WN8-21	3.70	5.00	930	115	120	8.56
4WN8-23	4.00	5.50	1030	115	120	9.20
4WN8-32	5.50	7.50	1340	115	120	12.00
4WN10-7	1.10	1.50	580	110	110	5.66
4WN10-10	1.50	2.00	770	110	110	7.18
4WN10-14	2.20	3.00	950	115	120	9.27
4WN10-18	3.00	4.00	1280	115	120	11.35
4WN10-22	3.70	5.00	1510	115	120	13.40
4WN10-24	4.00	5.50	1620	115	120	14.36
4WN10-32	5.50	7.50	2050	210	230	30.59
4WN12-7	1.50	2.00	580	110	110	5.66
4WN12-10	2.20	3.00	770	110	110	7.18
4WN12-14	3.00	4.00	950	115	120	9.37
4WN12-17	3.70	5.00	1150	115	120	11.00
4WN12-19	4.00	5.50	1340	115	120	12.00
4WN12-26	5.50	7.50	1680	115	120	15.60
4WN12-38	7.50	10.00	2440	210	230	28.33
4WN15-8	2.20	3.00	770	110	110	7.18
4WN15-11	3.00	4.00	950	115	120	8.87
4WN15-13	3.70	5.00	1090	115	120	10.17
4WN15-15	4.00	5.50	1220	115	120	11.45
4WN15-20	5.50	7.50	1620	115	120	14.66
4WN15-26	7.50	10.00	2070	210	230	28.95